

ICOM

INSTRUCTION MANUAL

DUAL BAND FM TRANSCEIVER

IC-W2A IC-W2E

icom Inc.



The photo shows IC-W2E with BP-82 BATTERY PACK. The battery pack and antenna differ according to versions.

IMPORTANT

READ ALL INSTRUCTIONS carefully and completely before using the transceiver.

SAVE THIS INSTRUCTION MANUAL —

This instruction manual contains important safety and operating instructions for the IC-W2A/E.

The use of non-Icom battery packs/chargers may impair transceiver performance and invalidate the warranty.

FOREWORD

Thank you for purchasing the **IC-W2A/E DUAL BAND FM TRANSCEIVER**. A state-of-the-art transceiver, the **IC-W2A/E** has the following features:

- Simultaneous receiving and displaying of the 144 MHz and 430 (440) MHz bands.
- Unbelievably small — just fits in the palm of your hand.
- Volume and squelch controls for separate VHF and UHF control.

CAUTIONS

NEVER connect the transceiver to an AC outlet or to a power source of more than 16 V DC. These connections will ruin the transceiver.

NEVER connect the transceiver to a power source using reverse polarity. This connection will damage the transceiver.

NEVER allow children to touch the transceiver.

AVOID using or placing the transceiver in areas with temperatures below -10°C ($+14^{\circ}\text{F}$) or above $+60^{\circ}\text{C}$ ($+140^{\circ}\text{F}$).

AVOID placing the transceiver in direct sunlight.

OPERATING NOTES

BE CAREFUL! When transmitting for a long time with high output power, the rear panel may become hot.

When using the transceiver with a small-capacity battery pack such as BP-81 or BP-82, we recommend operating with low output power. Battery power will be discharged quickly if the transceiver is operated continuously using high output power.

TABLE OF CONTENTS

IMPORTANT	i
FOREWORD	i
CAUTIONS	i
OPERATING NOTES	i
TABLE OF CONTENTS	ii
UNPACKING	ii
1. BASIC OPERATION	1~4
2. PANEL DESCRIPTION	5~10
3. CHARGING A BATTERY PACK	11~12
4. ACCESSORY INFORMATION	13~14
5. SETTING A FREQUENCY	15~18
6. REPEATER OPERATION	19~20
7. MODE ARRANGEMENT	21~22
8. CALL CHANNEL	23
9. MEMORY OPERATION	24~26
10. SCAN OPERATION	27~31
11. PRIORITY WATCH	32
12. DTMF MEMORY OPERATION	33
13. BEEP AND POWER SAVER	34
14. CLOCK AND TIMER OPERATION	35~40
15. PAGER AND CODE SQUELCH	41~44
16. POCKET BEEP AND TONE SQUELCH	45~46
17. TROUBLESHOOTING GUIDE	47
18. SPECIFICATIONS	48

UNPACKING

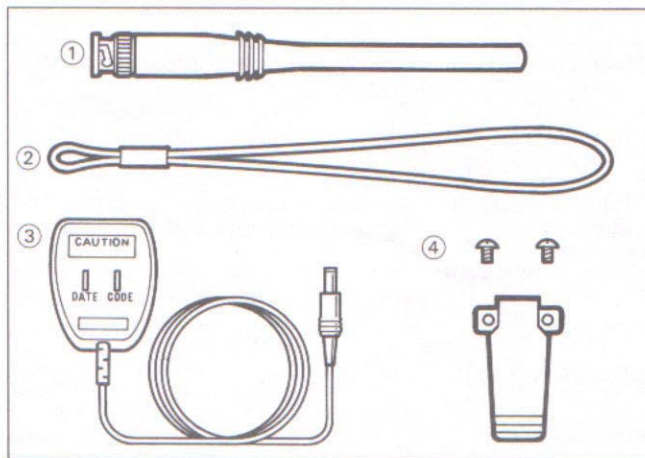

- | | |
|--------------------------------------|------|
| ① Flexible antenna*1 | 1 |
| ② Handstrap | 1 |
| ③ Wall charger*2 | 1 |
| ④ Belt clip and screws | 1set |
| Battery pack or battery case*3 | 1 |

*1 The diagram differs from the antenna attached with the U.S.A. version.

*2 Not included in some versions which are attached to battery cases.

*3 Either BP-82, BP-83, BP-84 or BP-90 will be attached to the transceiver depending on your version.

1 Before operation

Some keys on the front panel have 3 or 4 different functions. The function depends on the following procedures:

Digits (1 ~ 0)	Activated for frequency setting after pushing [Ⓜ ENT].
Functions written in gray	Activated by simply pushing the key.
Functions written in blue	Activated by pushing the key while pushing [F] on the side panel.
Digits and letters (1 ~ 0 and A ~ D)	Activated for DTMF transmission while [PTT] is being pushed.

[EXAMPLE]:

Push this key:
Switches VFO and MEMORY mode.

Push this key after pushing [Ⓜ ENT]:
Inputs "1" for frequency entry.

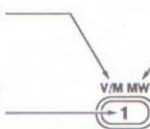

Push this key while pushing [F]:
Writes the displayed data into a memory channel.

[① V/M] and [① MW] are used here as examples.

2 Charge the battery pack

The supplied battery pack may require a full charge prior to operation.

Turn the transceiver power OFF and then connect the supplied wall charger as described in the diagram below.

- The CPU back-up battery will also be fully charged.
- See p. 12 or p. 14 for details on safety and use of a desktop charger or battery case.

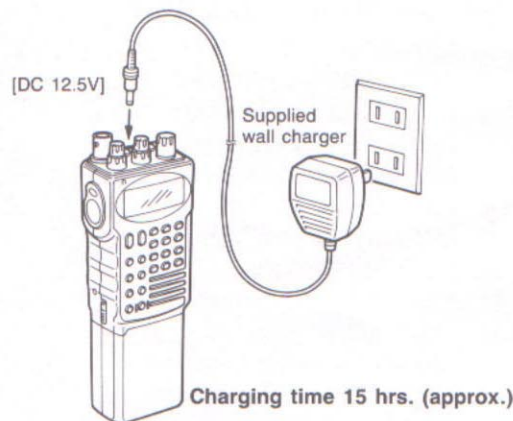

CAUTION: DO NOT forget to attach the jack cap after battery charging is finished. The jack cap prevents bad contact caused by dust.

3 Reset the transceiver

If the display shows erroneous information when first applying power, the transceiver may require CPU resetting.

- 1) While pushing the [F], [U MAIN] and [⊕ CLR] keys, push [POWER] for 1 sec. to turn power ON.
- 2) The CPU is reset and the function display shows as follows:
 - U.S.A. version
146.01, 440.00 MHz
 - Asia version
146.01, 430.00 MHz
 - Other versions
145.00, 430.00 MHz



When the internal CPU backup battery is not charged, keep the battery pack or battery case attached for at least 2 hours. If, however, you have followed the charging instructions on p. 1, the backup battery is already fully charged.

4 Connect the supplied antenna

Insert the supplied antenna into the antenna connector and twist the antenna as shown in the diagram.

CAUTION:

Transmitting without an antenna may damage the transceiver.

To attach other accessories such as a belt clip, hand-strap etc., see p. 13.

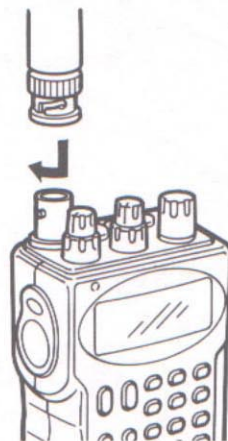

1 BASIC OPERATION

5 Turn power ON

Push and hold the [POWER] key for 1 sec. to turn power ON.

- A beep sounds at power ON.



6 Set the audio level

- 1) Set the VHF audio level:

- Rotate the VHF [SQL] max. counterclockwise.
- Set VHF [VOL] to the desired level.
- Set VHF [SQL] to mute audio noise while no signal is being received.

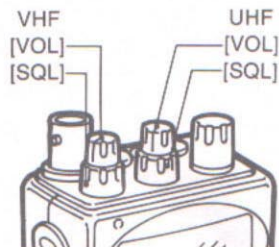

- 2) Set the UHF audio level:

- Rotate UHF [SQL] max. counterclockwise.
- Set UHF [VOL] to the desired level.
- Set UHF [SQL] to mute audio noise while no signal is being received.

7 Set the frequency

- Using the main dial

- 1) To set the VHF frequency, push [V MAIN] then rotate the main dial.
- 2) To set the UHF frequency, push [U MAIN] then rotate the main dial.

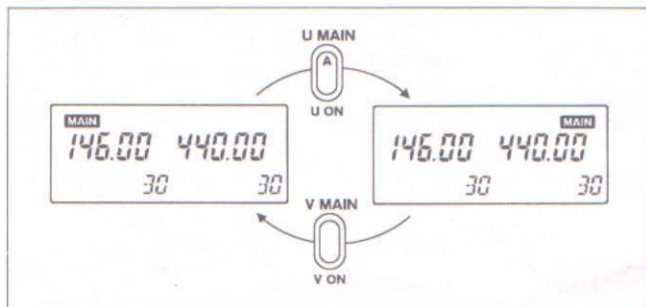

- Using the keyboard

Push [# ENT], then push 4 digit keys.

- Others

Advanced frequency setting methods are possible via the keyboard, main dial, etc. See pgs. 15 – 17 for details.

8 When receiving a signal

The transceiver can receive a VHF and a UHF signal simultaneously. When receiving, the transceiver functions as follows:

1. Emits the received signal(s) from the speaker.
2. Indicates the relative signal strength on the received band S-indicator on the function display.

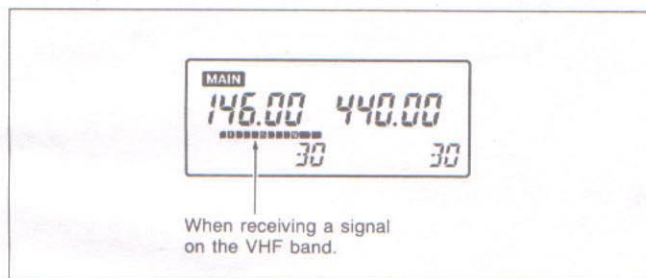

NOTE: When a [SQL] control is set too "tight" (extremely clockwise), squelch may not open for weak signals. At this time, set the squelch to a "loose" (less clockwise) position, or push and hold the [MONI] key.

9 Transmit a signal

The transceiver cannot transmit on both bands simultaneously.

NOTE: To prevent howling, AVOID setting the UHF frequency near the 3rd multiple of the VHF frequency, example, setting for 145.00 MHz and 435.00 MHz.

- 1) Push [V MAIN] or [U MAIN] to select the desired band for transmitting.
- 2) Push [9] HI/LOW to select high or low output.
 - "Low" conserves battery power and "high" ensures long distance communications.
 - "LOW" appears when low power is selected.
- 3) Push and hold [PTT] to transmit.
 - The LED indicator on the front panel lights up to red when transmitting. (The indicator is orange if the other band is in receive.)
- 4) Speak into the microphone.
 - DO NOT hold the transceiver too closely to your mouth or speak too loudly. This may distort the signal.
- 5) Release [PTT] to receive.
 - To use the repeater for long distance communications, see p. 19 for details.

■ Top and side panels

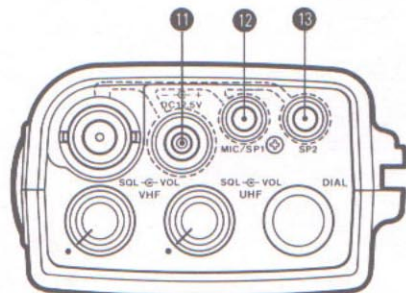
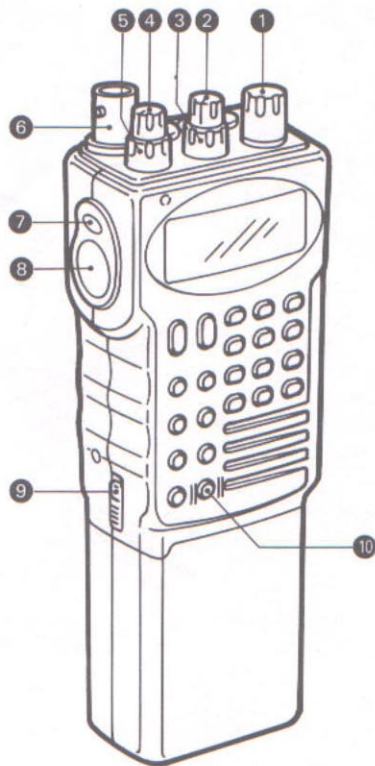

- 1 MAIN DIAL [DIAL]**
Sets an operating frequency, a memory channel, contents in SET mode, etc.
- 2 UHF VOLUME CONTROL [VOL] (p. 3)**
Adjusts the UHF band audio level.
- 3 UHF SQUELCH CONTROL [SQL] (p. 3)**
Varies the squelch threshold point for UHF band noise mute.
- 4 VHF VOLUME CONTROL [VOL] (p. 3)**
Adjusts the VHF band audio level.

- 5 **VHF SQUELCH CONTROL [SQL]** (p. 3)
Varies the squelch threshold point for VHF band noise mute.
- 6 **ANTENNA CONNECTOR** (p. 2)
Connects the supplied flexible antenna.
- 7 **FUNCTION SWITCH [F]** (pgs. 7, 8)
While pushing [F], all switches are set for secondary function use. (Functions written in blue are secondary functions.)
 - In VFO mode, the dial select function is activated. The dial select function changes the memory channel or changes the frequency in 100 kHz or 1 MHz steps by rotating the main dial.
- 8 **PTT SWITCH [PTT]** (p. 4)
Push and hold to transmit on the MAIN band frequency; release to receive.
- 9 **BATTERY PACK RELEASE BUTTON** (p. 14)
Opens the latch for battery pack removal when pushed upwards. Slide battery pack to the right for removal.
- 10 **POWER KEY [POWER]** (p. 2)
Turns power ON and OFF when pushed for 1 sec.

- 11 **EXTERNAL DC POWER JACK [DC12.5V]** (p. 11)
Connects the supplied wall charger for charging the battery pack.
 - Some versions which have a battery case do not come with a wall charger.

Allows operation with a 12.5 V DC power source using the optional cables, CP-13 or OPC-288 (see separate "List of options" for details).

- 12 **EXTERNAL SPEAKER/MICROPHONE JACK [MIC/SP1]**
Connect an optional speaker-microphone or headset, if desired (see separate "List of options" for details).
See the description of the [SP2] for detailed use of this jack.

- 13 **EXTERNAL SPEAKER JACK [SP2]**
Connect an optional earphone or external speaker, if desired.

	Internal speaker	SP1 output	SP2 output
With no external jacks	VHF/UHF (mixed)	—	—
With SP1 jack	—	VHF/UHF (mixed)	—
SP2 only	VHF	—	UHF
With both SP1 and SP2 jacks	—	VHF	UHF

2 PANEL DESCRIPTION

■ Front panel

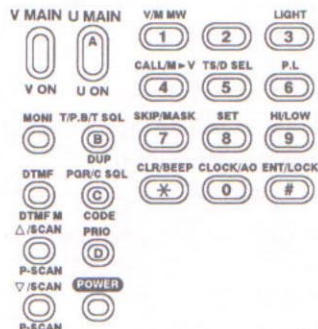

KEY	FUNCTION	WHILE PUSHING [F]
 V MAIN V ON	Selects the VHF band as the MAIN band. (p. 3)	Activates the transceiver for the VHF band only. (p. 18)
 U MAIN U ON	Selects the UHF band as the MAIN band. (p. 3)	Activates the transceiver for the UHF band only. (p. 18)
	Opens the squelch and the optional tone squelch of the main band. (p. 4)	Opens the squelch and optional tone squelch of the sub band.
 T/P,B/T SQL DUP	Turns ON the following optional functions* in this sequence: subaudible tone encoder → pocket beep → tone squelch → non-tone operation. (pgs. 20, 46)	Selects the following in this sequence: —duplex → +duplex → simplex. (Pgs. 19, 20)
 DTMF DTMF M	Emits the programmed DTMF memory code. (p. 33)	Enters DTMF MEMORY mode to program the DTMF memory. (p. 33)
 PGR/C SQL CODE	Turns ON the following optional functions in this sequence: Pager function → code squelch → non-selective call operation. (pgs. 41 ~ 44)	Used for programming the code memory for pager and code squelch. (p. 42)
 Δ/SCAN ▽/SCAN P-SCAN P-SCAN	Changes the frequency. (p. 15) Starts the full scan or memory scan when pushed and held. (pgs. 27, 28)	Starts the programmed scan or memory skip scan. (pgs 27, 28)
 PRIO PRIO	Starts the priority function. (p. 32)	No secondary function.
 POWER POWER	Turns power ON and OFF when pushed for 1 sec. (p. 2)	The same function as at left.

*Built-in to the U.S.A. version

KEY	FUNCTION	WHILE PUSHING [F]	AFTER PUSHING [ENT]
V/M MW 1	Selects VFO or MEMORY mode. (p. 24)	Writes the VFO contents into the memory channel or call channel when pushed and held. (pgs. 23, 25)	Inputs digits for frequency setting. (p. 16)
2	Used only for numeral input.	No secondary function.	
LIGHT 3	Turns ON the display lighting for 5 sec. (p. 34)	Turns ON the display lighting continuously. (p. 34)	
CALL/M→V 4	Calls up the call channel. (p. 23)	Transfers the contents in the selected memory or call channel into the VFO. (p. 26)	
T&D SEL 5	Selects the tuning step. Use the switch together with the main dial. (p. 17)	Selects the dial select step from among 100 kHz, 1 MHz or memory channel changing. (p. 17)	
P.L. 6	Used only for numeral input.	Turns the PTT lock function ON and OFF. (p. 18)	
SKIP/MASK 7	Sets the selected memory channel as a skip channel. (p. 31)	Hides and displays the selected memory channel. Memory channel 1 cannot be hidden. (p. 26)	
SET 8	Used only for numeral input.	Enters SET mode. (p. 22)	
HVLOW 9	Selects high or low output power. (p. 4)	Selects low output power in 3 levels. Use this function together with the main dial. (p. 18)	
CLR/BEEP *	Clears the input digit before entry. Exits the SET and CLOCK modes. (pgs. 16, 22)	Turns the beep function ON and OFF. (p. 34)	
CLOCK/AO 0	Enters CLOCK mode. (p. 35)	Turns the auto off function ON and OFF. (p. 35)	
ENT/LOCK #	Sets the keyboard for numeral use. (p. 16)	Turns the lock function ON and OFF. (p. 15)	

2 PANEL DESCRIPTION

■ Function display

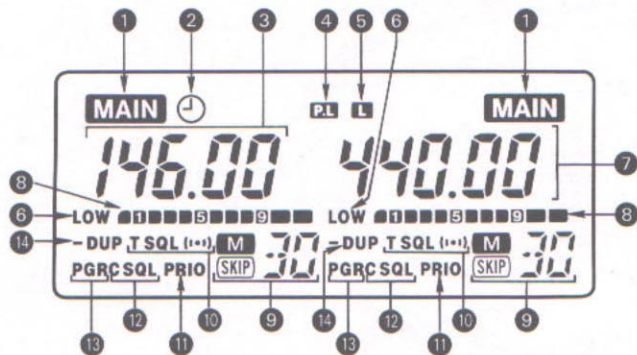

- 1 MAIN BAND INDICATORS** (p. 3)
"MAIN" appears above the band, either VHF or UHF, selected as the main band to be controlled.
- 2 TIMER INDICATOR** (p. 39)
Appears when the power-off timer is in use.
- 3 VHF BAND FREQUENCY READOUT**
Shows the VHF band frequency, SET mode contents or time.
 - The decimal point of the frequency flashes while scanning.
- 4 PTT LOCK INDICATOR** (p. 18)
Appears when the PTT lock function is in use.
- 5 LOCK INDICATOR** (p. 15)
Appears when the lock function is in use.
- 6 LOW POWER INDICATOR** (p. 4)
Appears when low output power is selected.
- 7 UHF BAND FREQUENCY READOUT**
Shows the UHF band frequency, SET mode contents or time.
 - The decimal point of the frequency flashes while scanning.

8 S/R/F INDICATORS (pgs. 4, 18)

Show the relative signal strength in receiving; show the output power selection in transmitting.

9 MEMORY CHANNEL READOUTS (pgs. 24 ~ 26)

Show the selected memory channel number.

- **M** appears when MEMORY mode is selected.
- **SKIP** appears when the selected memory channel is set as a skip channel.

10 TONE SQUELCH INDICATORS (pgs. 19, 46)

These indicators appear when an optional* UT-63 TONE SQUELCH UNIT is in use.

- "T" appears when the subaudible tone encoder is used.
- "T SQL" appears when the tone squelch is used.
- "T SQL (••)" appears when the pocket beep function is in use.
- (••) flashes when the pocket beep function is in use and receiving a call

*Built-in to the U.S.A. version.

11 PRIORITY INDICATORS (p. 32)

Appear when the priority watch is activated; flashes when the watch is paused.

12 CODE SQUELCH INDICATORS (pgs. 41, 44)

Appear when the code squelch is in use.

13 PAGER INDICATORS (pgs. 41 ~ 44)

Appear when the pager function is turned ON; flashes when a call is received.

14 DUPLEX INDICATORS (p. 19)

Appear when the duplex is used for repeater operation.

- "DUP" appears when + duplex is selected. (When the repeater input frequency is higher than the repeater output frequency.)
- "—DUP" appears when —duplex is selected. (When the repeater input frequency is lower than the repeater output frequency.)

3

CHARGING A BATTERY PACK

• Using supplied wall charger

Connect the supplied wall charger to the [DC12.5V] jack.

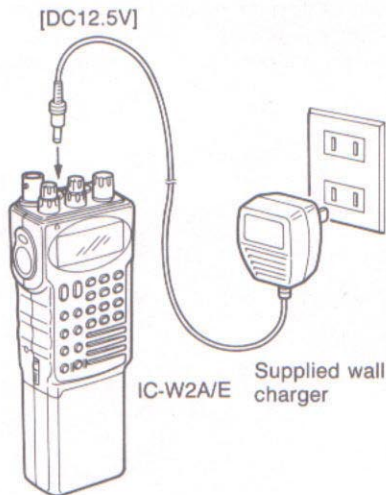

Charging time: 15 hrs. (approx.)

• Using an optional BC-72

Insert the battery pack into the charging slot of the BC-72.

BP-90 BATTERY CASE cannot be charged using the BC-72 even when NiCd batteries are installed.

Connect the wall charger supplied with the BC-72.

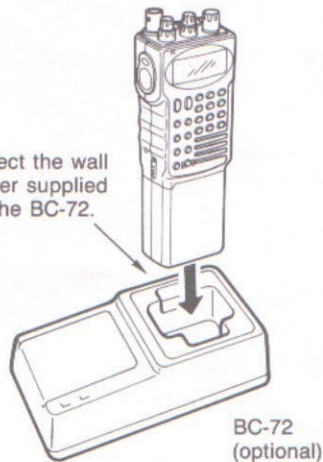

Charging time: 1~3 hrs. (approx.)

• Optional charger and cables

CP-13 (optional)

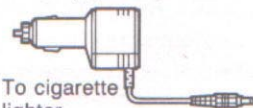

To cigarette lighter socket

OPC-288 (optional)

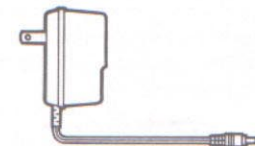
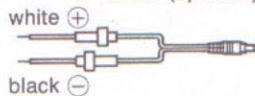

BC-77A/E/D/V
for BP-81 ~ BP-84, BP-90.

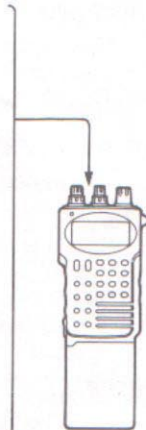

To charge BP-85, use BC-74A/E/D/V, CP-12 or OPC-254.

Charging time is 15 hrs. (approx.)

• Charging without the transceiver

To charge the battery pack separately from the transceiver, AD-20 is available from Icom.

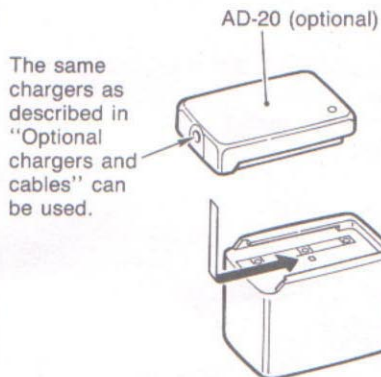

The BP-85 cannot be charged via an optional AD-20.

Charging time is 15 hrs. (approx.)

• Charging notes

- NEVER attempt to charge dry cell batteries with the BP-90.
- Connect one charger as described at left. NEVER connect two or more chargers at the same time.
- When transceiver power is ON during charging, the charging time is longer than the described time.
- Charging may not be performed in extreme cold (under 0°C; +32°F) or extreme heat (over +40°C; +104°F).

• Battery life

Each battery pack has operating times described in the table at right when transmitting at high power for 1 min., receiving for 1 min. and stand-by for 8 min.

BATTERY	OUTPUT VOLTAGE	APPROXIMATE OPERATING TIME*	
		144 MHz	430(440) MHz
BP-81	7.2 V	1 h.	1 h.
BP-82	7.2 V	2 h. 30 m.	2 h. 30 m.
BP-83	7.2 V	5 h. 20 m.	5 h. 20 m.
BP-84	7.2 V	9 h. 10 m.	9 h. 10 m.
BP-85	12.0 V	2 h. 10 m.	1 h. 30 m.

* Operating times may vary depending on operating conditions such as output power, temperature, etc.

• Using your battery wisely

Although battery packs may not be affected by charging for one week or more, overcharging and complete discharging shorten the life of a battery.

Recharging can usually be performed 300 times, but battery life can be lengthened to about 500 recharges as follows:

1. Avoid overcharging. Charging times should be less than 48 hours.
2. Use the battery until it is almost completely discharged under normal conditions. We recommend battery charging as soon as transmitting becomes impossible.

• Handstrap attachment

The handstrap allows you to carry the transceiver easily. Attach the handstrap as shown in the diagram.

1. Insert the handstrap using a pointed tool such as a sharp pencil.

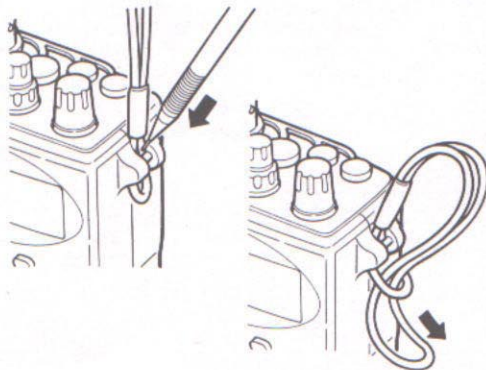

2. Put one end of handstrap through the other end's loop.

3. Pull the handstrap to tighten the knot.

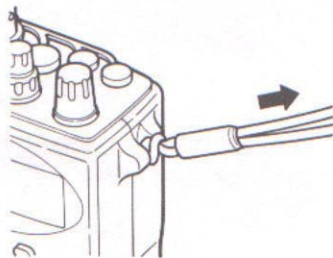

• Belt clip attachment

The belt clip allows you to attach the transceiver to your belt.

Remove the plastic screws to attach the belt clip.

To use an optional MB-20 ALLIGATOR CLIP with the IC-W2A/E, use the supplied screws with the transceiver. NEVER use the screws supplied with the alligator clip.

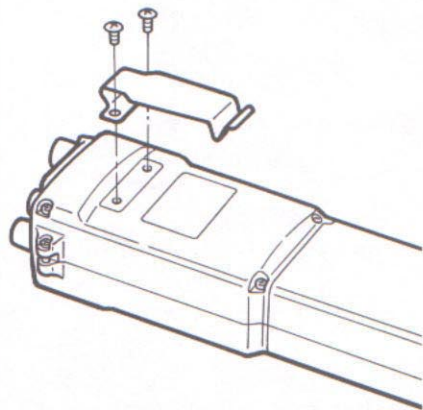

• Battery pack removal

Push the battery pack release button upwards, then slide the battery pack to the right with the transceiver facing you.

To attach the battery pack, slide it until hearing a click sound.

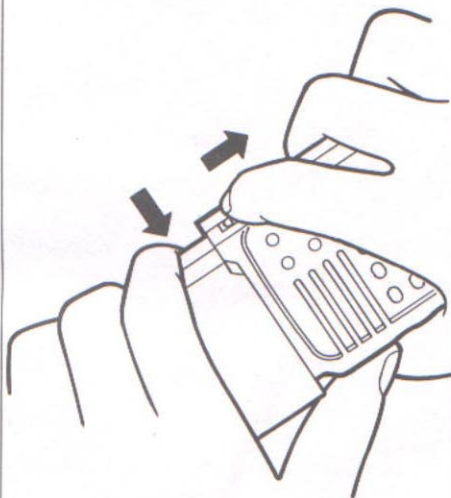

• Battery case

Some versions include a battery case instead of the battery pack.

To install dry cell batteries, open the battery case as shown in the diagram below.

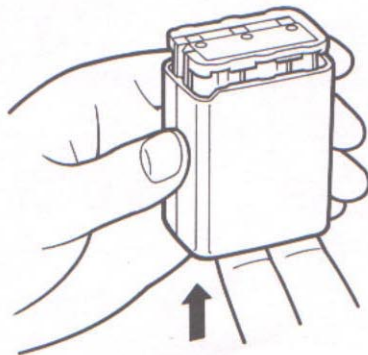

1. Push the bottom part of the battery case to open it.

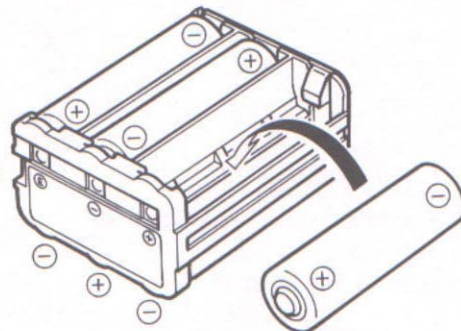

2. Install six AA(R6) type batteries. Be careful of the polarity of the batteries.

■ Pre-operation note

VFO MODE

When the transceiver is not in VFO mode, frequency setting is impossible. Push [1] V/M or [4] CALL to select VFO mode.

- Mode information is described on p. 21.

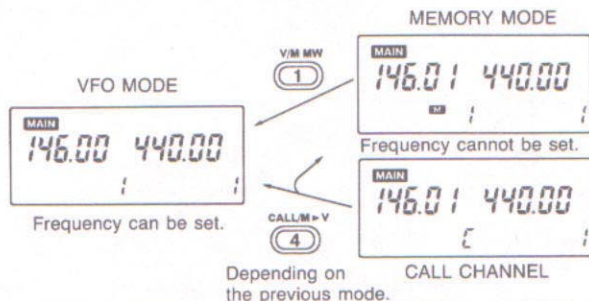

LOCK FUNCTION

When the lock function is activated, the main dial and keyboard will not function. Use the lock function to prevent accidental frequency changing.

- While pushing [F], push [LOCK] to turn the lock function ON and OFF.

If "L" appears, frequency cannot be set.

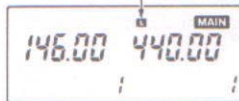

■ Using the main dial

- 1) Push [V MAIN] or [U MAIN] to select the desired band.
- 2) Rotate the main dial to set the frequency.
- 3) To change the frequency quickly, rotate the main dial while pushing [F].
 - See p. 17 "Setting a dial select step" for details.

■ Using Δ and ∇ keys

- 1) Push [V MAIN] or [U MAIN] to select the desired band.
- 2) Push [Δ /SCAN] or [∇ /SCAN] to change the frequency.
 - Holding the key for more than 0.5 sec. may activate full scan.
 - If the scan is started, push [Δ /SCAN] or [∇ /SCAN] again to stop the scan.

■ Using numeral keys

- 1) Push [V MAIN] or [U MAIN] to select the desired band.
- 2) Push [# ENT] to activate the keyboard for numeral input.
- 3) Push 4 appropriate digit keys to input a frequency.
 - When a wrong digit is input, push [* CLR] to clear the input, then start again from step 2.
 - "5" or "0" are acceptable for 1 kHz digits; "2" or "7" are also acceptable depending on the 10 kHz digit.

[EXAMPLE] Set the frequency to 146.520 MHz.

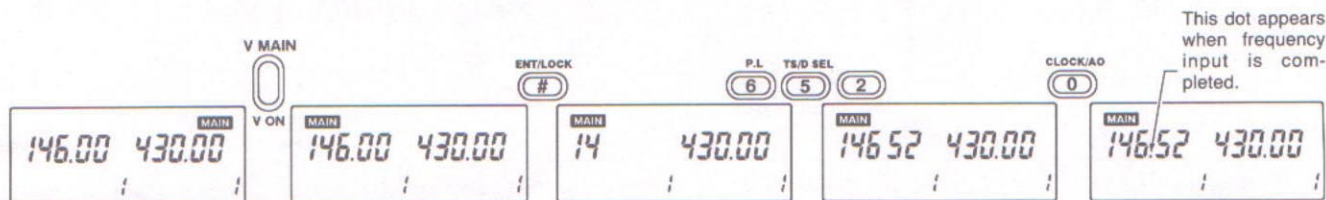

[EXAMPLE] Set frequency to 435.3125 MHz.

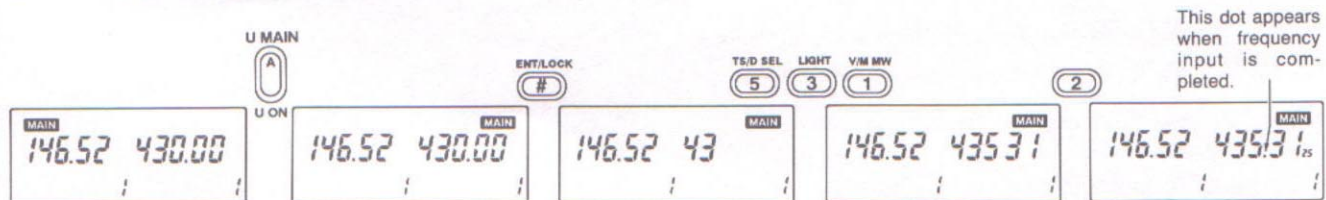

5 SETTING A FREQUENCY

■ Setting a tuning step

The main dial or the Δ/∇ keys change the frequency in step increments. Different tuning steps can be specified for the VHF and UHF band.

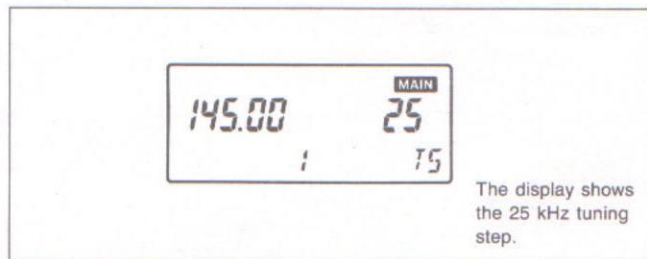

- 1) Push [V MAIN] or [U MAIN] to select the desired band.
- 2) Push [① V/M] to select VFO mode. ("M" disappears.)
- 3) Push [⑤ TS] to display the previously selected tuning step.
 - 5, 10, 12.5, 15, 20, 25, 30 and 50 kHz steps are available.
- 4) Rotate the main dial to select the desired tuning step.
- 5) Push [⊛ CLR] to return to frequency indication.

■ Setting a dial select step

In VFO mode, while pushing the [F] key, the main dial changes the frequency in 100 Hz or 1 MHz increments or changes the memory channel according to the select step increment.

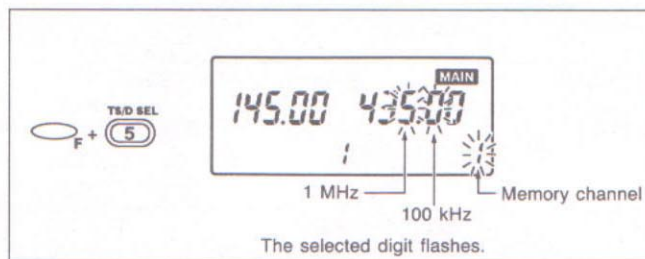

- 1) Push [V MAIN] or [U MAIN] to select the desired band.
- 2) While pushing [F], push [⑤ D SEL] to change the dial select step.
 - The selected digit flashes while pushing [F].

■ One band indication

When using the IC-W2A/E as a single band transceiver, one-band indication can be performed. At this time, the internal circuits of the unused band are also deactivated.

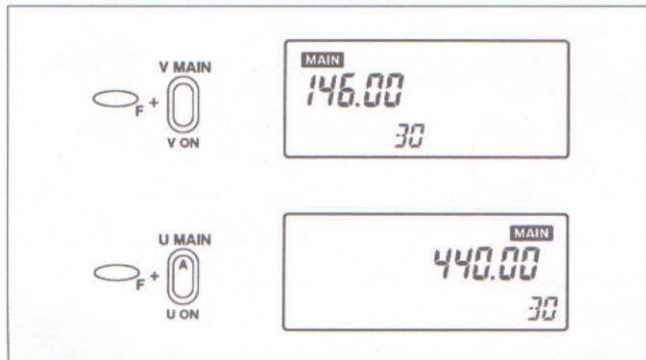

- 1) While pushing [F], push [V MAIN] or [U MAIN] to hide the display of the unused band.
- 2) Push [V MAIN] or [U MAIN] to indicate the display of the band in use.

One band indication conserves battery power.

■ PTT lock function

The PTT lock function electronically locks the PTT switch to prevent accidental transmission.

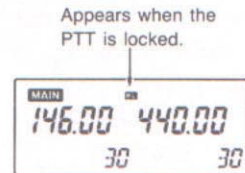

While pushing [F], push [6] P.L] to turn the PTT lock function ON and OFF.

■ Low output power

Low output power can be selected in 3 levels to suit operating requirements. The level can be set separately in the VHF and UHF bands.

- 1) Push [V MAIN] or [U MAIN] to select the desired band.
- 2) While pushing [F], push [9] HI/LOW]; then, while continuing to hold [F], rotate the main dial to set the desired level.
 - The S/R/F indicator shows the selected level as in the table below.

Power selection	S/R/F indicator	Output power	
		with 13.5 V	with 7.2 V
Low 1	LOW ■■	0.5 W	0.5 W
Low 2	LOW ■■■■■■	1.5 W	1.5 W
Low 3	LOW ■■■■■■■■■■	3.5 W	1.5 W
High	■■■■■■■■■■■■■■■■	5.0 W	1.5 W

Above values are typical.

■ General description

A repeater amplifies the received signal and transmits it with a different frequency. When using a repeater, the transmit frequency is therefore, shifted from the receive frequency by the offset frequency.

- 1) Push [V MAIN] or [U MAIN] to select the desired operating band.
- 2) Set the receive frequency using the main dial or the keyboard.
- 3) While pushing [F], push [Ⓟ DUP] to select —duplex and push it again for +duplex.
 - “—DUP” or “DUP” appears to indicate the transmit frequency for minus shift or plus shift respectively.
- 4) Push and hold [PTT] to transmit.
 - The displayed frequency automatically changes to the repeater input frequency.
 - When the repeater requires a tone, see “Tone information” at right.
- 5) Release [PTT] to receive.
- 6) Push and hold [MONI] to check whether the repeater input frequency can be directly received or not.

■ Tone information

SUBAUDIBLE TONE ENCODER

(Non-U.S.A. versions require an optional UT-63.)

- 1) Push [Ⓟ T/P.B/T SQL] to turn ON the subaudible tone encoder.
 - To set the subaudible tone frequency, see the page at right “Subaudible tone frequency.”
- 2) Push [Ⓟ T/P.B/T SQL] 3 times until “T” disappears to turn OFF the subaudible tone encoder.

DTMF TONES

While pushing [PTT], push the desired digit key to transmit DTMF tones.

DTMF memory is equipped in the transceiver. See p. 33 for details.

1750 Hz TONE CALL (IC-W2E only)

While pushing [PTT], push and hold [V MAIN] for 1 ~ 2 sec. to transmit a 1750 Hz tone.

■ Offset frequency

USING SET MODE

The offset frequency can be separately set on the UHF and VHF bands.

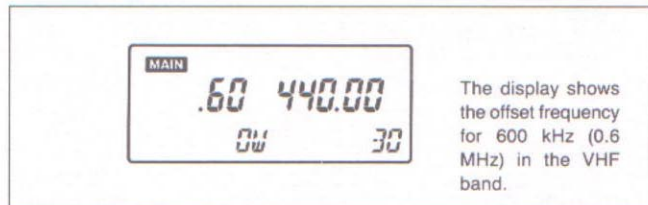

- 1) Push [V MAIN] or [U MAIN] to select the desired band.
- 2) Push [① V/M] to enter VFO mode. ("M" disappears.)
- 3) While pushing [F], push [⑧ SET] to enter SET mode.
 - Refer to p. 22 for SET mode details.
- 4) Push [Δ/SCAN] or [▽/SCAN] until "OW" appears as shown above.
- 5) Rotate the main dial to select the desired offset frequency.
 - For quick selection, rotate the main dial while pushing [F].
- 6) Push [⊛ CLR] to exit SET mode.

■ Subaudible tone frequency

USING SET MODE

The subaudible tone frequency can be set separately on the VHF and UHF bands.

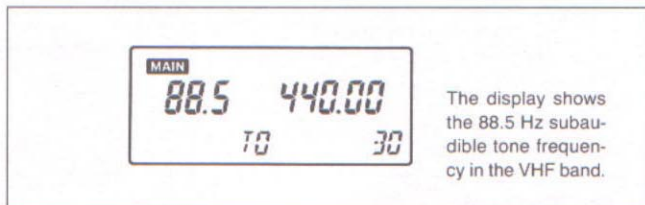

- 1) Push [V MAIN] or [U MAIN] to select the desired band.
- 2) Push [① V/M] to enter VFO mode. ("M" disappears.)
- 3) While pushing [F], push [⑧ SET] to enter SET mode.
 - Refer to p. 22 for SET mode details.
- 4) Push [Δ/SCAN] or [▽/SCAN] until "TO" appears as shown above.
- 5) Rotate the main dial to select the desired subaudible tone frequency.
- 6) Push [⊛ CLR] to exit SET mode.

7 MODE ARRANGEMENT

■ Mode types

The transceiver has 5 different modes and call channels for versatile, multi-function operations.

VFO MODE (p. 15)

Used for normal operations over the entire VHF and UHF bands.



CLOCK MODE (p. 35)

Used for setting the clock time, power-on time, and auto power-off time.

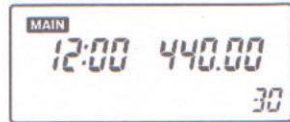

MEMORY MODE (p. 24)

Used for operating the transceiver using memory channel contents. Each band has 30 memory channels. A total of 60 memory channels are available.



DTMF MEMORY MODE (p. 33)

Used for programming DTMF codes. 4 DTMF memory channels are available and each memory channel has up to 15 digits of programming capability.

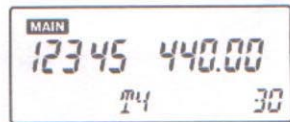

SET MODE

Used for programming infrequently used settings described on p. 22. VHF and UHF bands have separate SET modes.

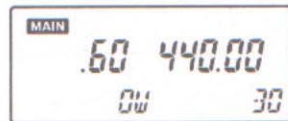

CALL CHANNEL (p. 23)

Used for operating the transceiver on a programmed call channel. VHF and UHF bands have their own separate call channel.

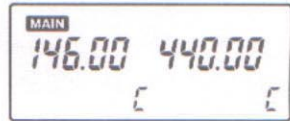

Mode arrangement chart

Although the following chart refers only to the VHF band, the transceiver has the same modes in the UHF band.

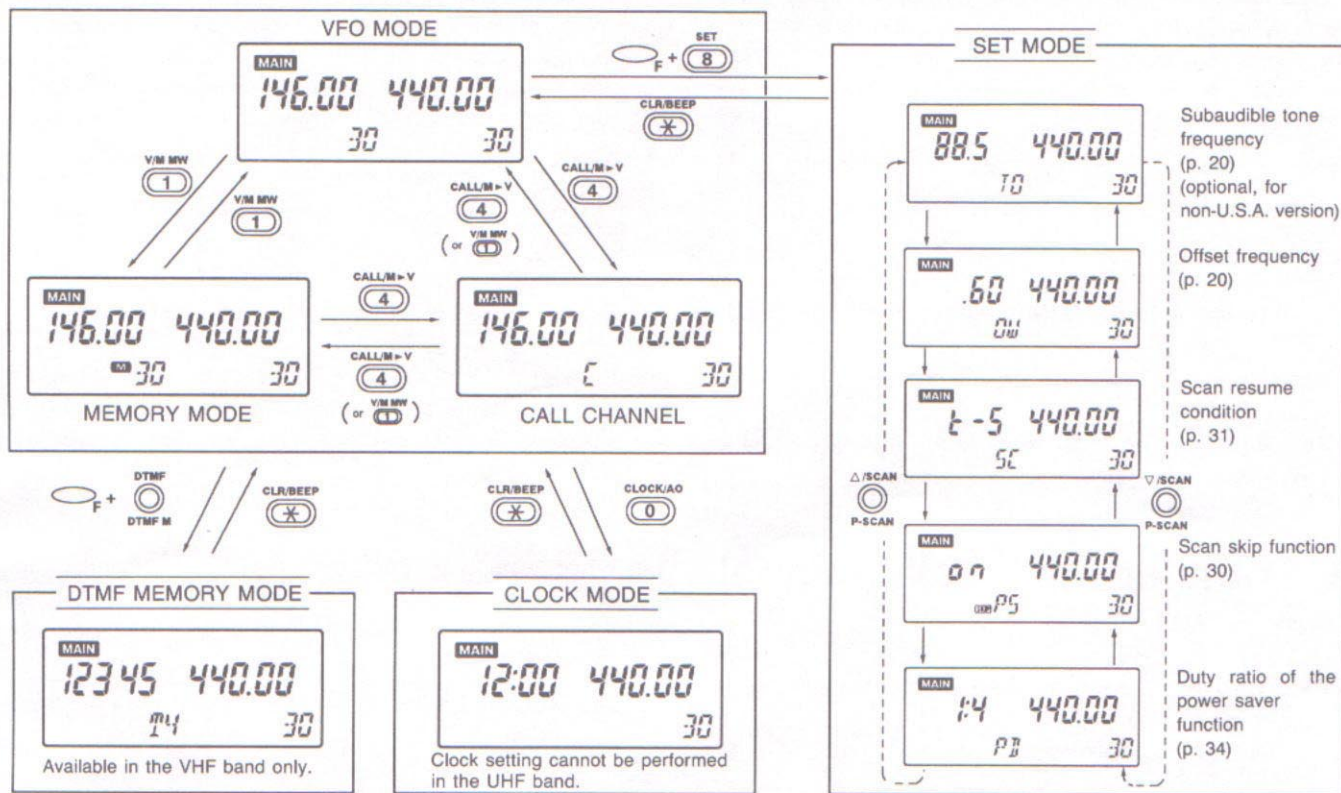

■ Calling up the call channel

A one-touch access call channel is provided on each band and is separate from the memory channels. Use the call channel for your most-often-used frequency.

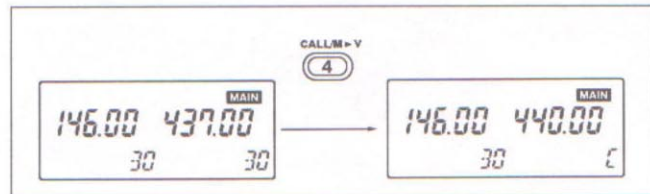

- 1) Push [V MAIN] or [U MAIN] to select the desired band.
- 2) Push [4 CALL] to display the call channel.
- 3) Push [4 CALL] again to return to the previous mode.
 - [1 V/M] can also return to the previous mode.

■ Transferring a call channel

- 1) Push [4 CALL] to call up the call channel.
- 2) While pushing [F], push and hold [4 M▶V] until the transceiver emits 3 beeps.
 - VFO mode is automatically selected.

■ Programming a call channel

Call channels can be programmed with not only an operating frequency but also a duplex function and independent off-set frequency.

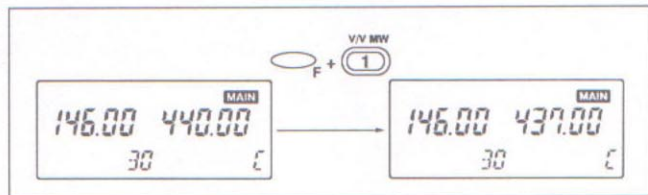

- 1) Push [V MAIN] or [U MAIN] to select the desired band.
- 2) Push [1 V/M] to select VFO mode; then, set the desired frequency to be programmed into the call channel.
 - Duplex information can also be programmed.
- 3) Push [4 CALL] to call up the call channel.
- 4) While pushing [F], push and hold [1 MW] until the transceiver emits 3 beeps.
 - Programming is completed and VFO mode is automatically selected.

■ Selecting a memory channel

The transceiver has 30 memory channels on each band for storage of often-used frequencies.

When first applying power or after resetting, memory channels 11 ~ 30 are masked.

When the dial select step is set as the memory channel, memory channels can also be selected in VFO mode. See p. 17 for setting the dial select step for memory channel changing.

- 1) Push [① V/M] to select MEMORY mode.
 - Only the memory channels which have been programmed with contents will appear.
 - Pushing [△/SCAN] or [▽/SCAN] also selects memory channels.
- 2) Rotate the main dial to select the desired memory channel.
 - Only the memory channels which have been programmed with contents will appear.
 - Pushing [△/SCAN] or [▽/SCAN] also selects memory channels.
- 3) To select blanked memory channels (i.e., channels without contents), rotate the main dial while pushing [F].
- 4) Push [① V/M] to return to VFO mode.

[EXAMPLE]: Select UHF memory channel 30 (When memory channel 30 is blank).

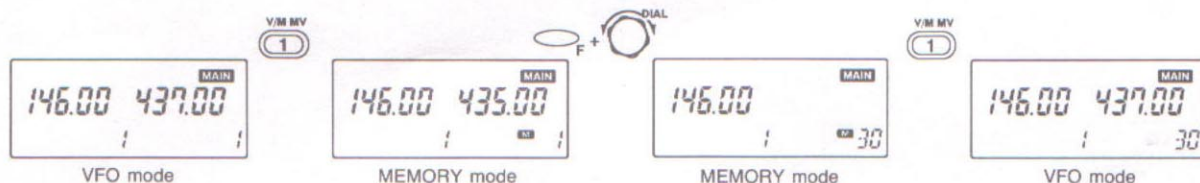

■ Programming a memory channel

- 1) Select the memory channel to be programmed:
 - Push [V MAIN] or [U MAIN] to select the desired band.
 - Push [① V/M] to select MEMORY mode. ("M" appears).
 - Rotate the main dial to select the desired memory channel.
 - To select blank channels, rotate the main dial while pushing [F].
- 2) Set the desired frequency in VFO mode:
 - Push [① V/M] to select VFO mode.
 - Set the desired frequency to be programmed into the memory channel.
 - Duplex information can also be programmed.
- 3) While pushing [F], push and hold [① MW] until the transceiver emits 3 beeps.

[EXAMPLE]: Program 145.375 MHz into memory channel 25.

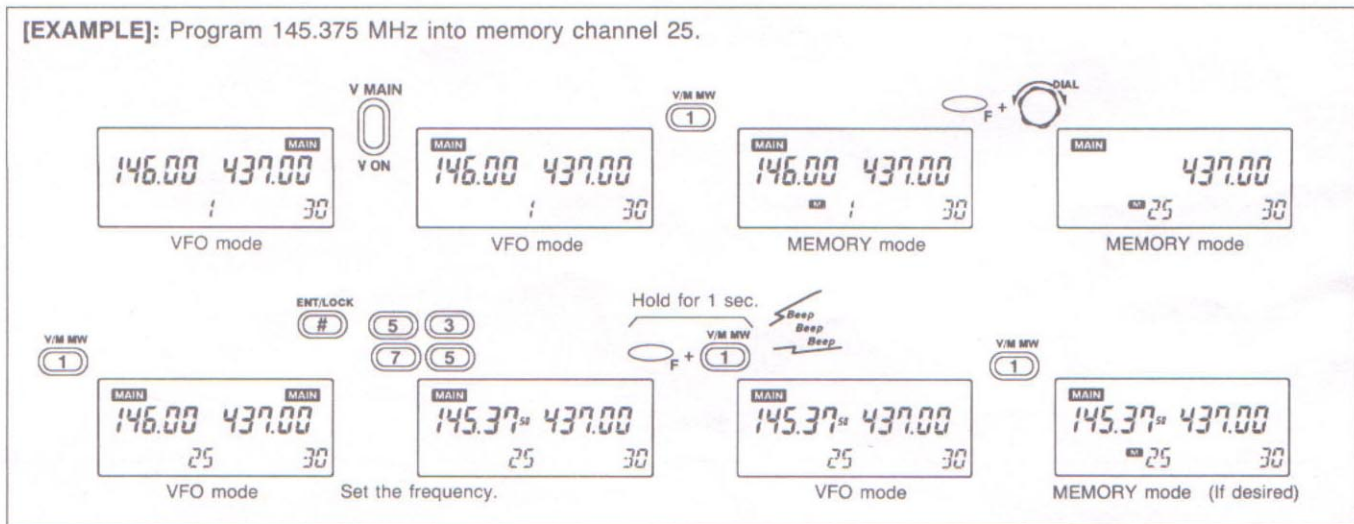

■ Transferring memory contents

The function copies and transfers the displayed memory contents into the VFO. This function is useful for searching for signals around the memorized frequency.

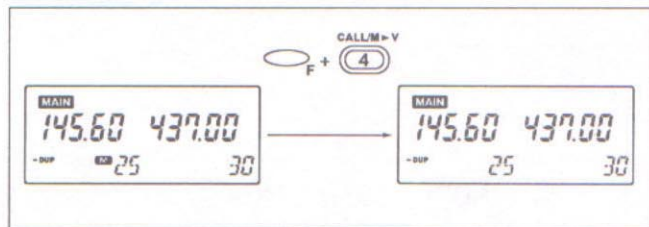

- 1) Select the memory channel to be transferred:
 - Push [V MAIN] or [U MAIN] to select the desired band.
 - Push [① V/M] to select MEMORY mode.
 - Rotate the main dial to select the desired memory channel.
- 2) While pushing [F], push and hold [④ M▶V] until the transceiver emits 3 beeps.
 - " M " disappears as VFO mode is automatically selected.

■ Masking memory contents

Unwanted memory channels can be masked (hidden). A masked memory channel cannot be selected for normal use. The contents of the masked memory, however, can be recalled by the following procedure.

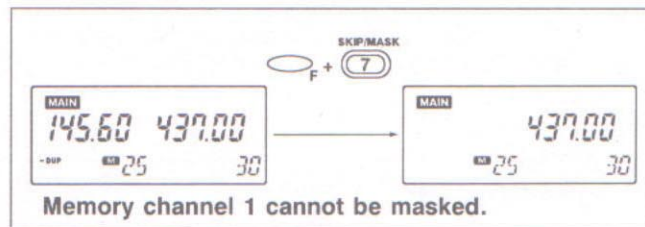

- 1) Select the memory channel to be masked:
 - Push [V MAIN] or [U MAIN] to select the desired band.
 - Push [① V/M] to select MEMORY mode.
 - Rotate the main dial to select the desired memory channel.
- 2) While pushing [F], push [⑦ MASK] to mask the memory channel.
- 3) To recall the masked memory contents, repeat step 2.

10 SCAN OPERATION

■ Scan types

• Full scan

Repeatedly scans all frequencies over the entire selected band.

- The frequency skip function can be used.

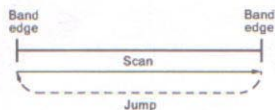

• Memory scan

Repeatedly scans all memory channels in sequence.

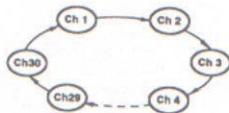

• Frequency skip function

Skips unwanted frequencies that inconveniently stop scanning.

- See p. 30 for programming.

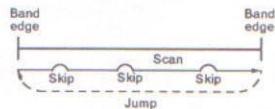

• Programmed scan

Repeatedly scans between two user-programmed frequencies.

- See p. 29 for scan edge programming. The frequency skip function can be used.

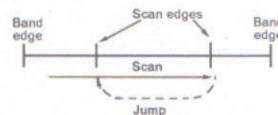

• Memory skip scan

Repeatedly scans memory channels. Memory channels programmed as the skip channels, however, are skipped while scanning.

- See p. 31 for skip channel programming.

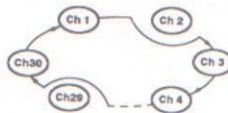

• Scan resume condition

2 resume conditions are available: pause scan and timer scan. When receiving a signal, pause scan pauses until the signal disappears; timer scan pauses for approx. 5 sec.

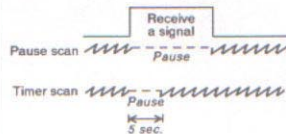

■ Scan operation

Read the following table horizontally for each type of scan; procedures in ①, ④, and ⑤ apply to all scan types.

SCAN TYPE	① PRE-OPERATION 1	② PRE-OPERATION 2	③ SCAN START	④ SCAN RESUME CONDITION	⑤ SCAN STOP
FULL SCAN		Push [① V/M] to select VFO mode.	Push and hold [Δ/SCAN] or [▽/SCAN] for 1 sec.		
PRO-GRAMMED SCAN	1) Push [V MAIN] or [U MAIN] to select the band to be scanned. 2) Set the [SQL] control to the threshold level.	1) Program the scan edge frequencies. (p. 29) 2) Push [① V/M] to select VFO mode.	While pushing [F], push [Δ/SCAN] or [▽/SCAN].	<ul style="list-style-type: none"> • Scan resumes 5 sec. after receiving a signal or 2 sec. after a signal disappears. • Rotating the main dial restarts scan and changes the scan direction. 	Push [Δ/SCAN] or [▽/SCAN].
MEMORY SCAN	NOTE: When the squelch is tight, the scan might not stop on a weak signal.	Push [① V/M] to select MEMORY mode.	Push and hold [Δ/SCAN] or [▽/SCAN] for 1 sec.	<ul style="list-style-type: none"> • Resume condition can be selected. See p. 31 for details. 	Pushing [* CLR] or [PTT] also stops the scan.
MEMORY SKIP SCAN		1) Push [① V/M] to select MEMORY mode. 2) Set the undesired channel as the skip channel. (p. 31)	While pushing [F], push [Δ/SCAN] or [▽/SCAN].		

■ Programmed scan edges

Programmed scan edges can be programmed in the same way as memory writing. Memory channels "PA" and "PB" are available for programmed scan edge programming.

- 1) Push [V MAIN] or [U MAIN] to select the desired band.
- 2) Select the scan edge memory channel "PA" or "PB":
 - Push [1] V/M to select MEMORY mode. ("M" appears).
 - Rotate the main dial to select the memory channel "PA" or "PB."

- 3) Set the desired edge frequency in VFO mode:
 - Push [1] V/M to select VFO mode.
 - Set the desired frequency to be programmed into the memory channel.
- 4) While pushing [F], push and hold [1] MW until the transmitter emits 3 beeps.
- 5) To program a frequency for the other scan edge memory channel "PB" or "PA," repeat steps 2~4.
 - If the same frequencies are programmed into "PA" and "PB," programmed scan will not function.

[EXAMPLE]: Program 145.50 MHz and 145.80 MHz for the scan edges.

The sequence of operations is as follows:

- Select VFO mode:** Press [V MAIN]. The display shows MAIN 145.00 437.00.
- Select memory channel "PA.":** Press [1] V/M MW, then rotate the dial. The display shows MAIN 145.00 437.00 with PA on the bottom line.
- Select 145.50 MHz in VFO mode:** Press [1] V/M MW, then rotate the dial. The display shows MAIN 145.50 437.00 with PA on the bottom line.
- Program:** Press [F] + [1] MW and hold for 1 second. The display shows MAIN 145.50 437.00 with PA on the bottom line. A beeping sound is indicated.
- Select memory channel "PB.":** Press [1] V/M MW, then rotate the dial. The display shows MAIN 145.00 437.00 with PB on the bottom line.
- Set 145.80 MHz in VFO mode:** Press [1] V/M MW, then rotate the dial. The display shows MAIN 145.80 437.00 with PB on the bottom line.
- Program is completed:** Press [F] + [1] MW and hold for 1 second. The display shows MAIN 145.80 437.00 with PB on the bottom line. A beeping sound is indicated.

■ Frequency skip function

• Programming a skip frequency

Frequencies can be skipped when the programmed scan or the full scan is in the pause condition. Memory channels 30~11 program skip frequencies in sequence.

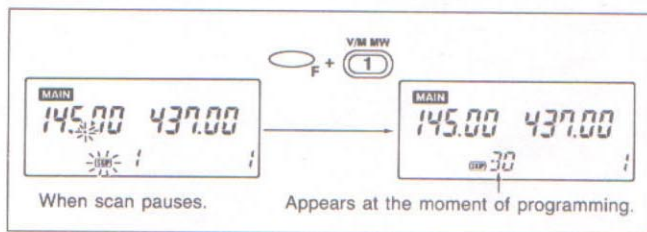

- 1) Turn ON the frequency skip function.
 - After CPU resetting, the function is automatically turned ON.
 - To turn the function ON or OFF, see "Frequency skip function ON/OFF" at right.
- 2) Start full scan or programmed scan.
 - See p. 28 "Scan operation" for details.
- 3) Program the received frequency as the skip frequency when scan is paused:
 - While pushing [F], push [1] V/M] for 1 sec.

• Frequency skip function ON/OFF

USING SET MODE

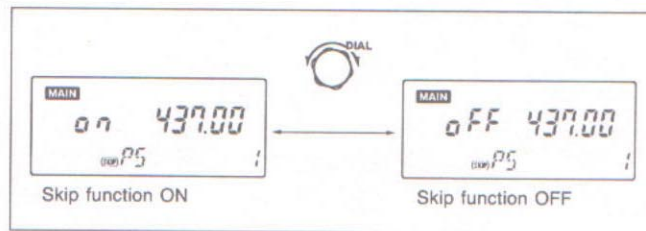

- 1) Enter SET mode:
 - Push [V MAIN] or [U MAIN] to select the desired band.
 - Push [1] V/M] to select VFO mode. ("M" disappears.)
 - While pushing [F], push [8] SET] to enter SET mode.
- 2) Select the frequency skip display:
 - Push [Δ/SCAN] or [▽/SCAN] several times until "SKIP PS" appears as shown above.
- 3) Rotate the main dial to turn the function ON or OFF.
- 4) Push [⊗] CLR] to exit SET mode.

■ Skip channel setting

Memory channels can be specified to be skipped for memory skip scan. These skip channels are also skipped during priority watch (memory scan watch) and the frequencies of the channels are skipped during full or programmed scan.

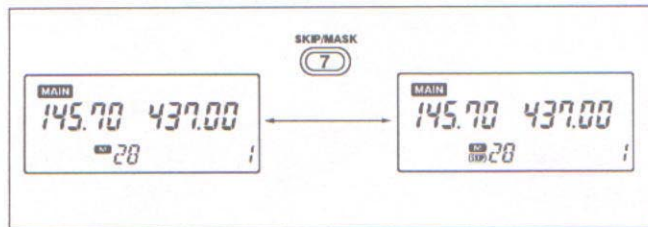

- 1) Select the memory channel to be programmed as the skip channel:
 - Push [① V/M] to select MEMORY mode. ("M" appears.)
 - Rotate the main dial to select the desired memory channel.
- 2) Push [⑦ SKIP] to set the memory channel to the skip channel.
 - "SKIP" appears.
- 3) Repeat the above steps to delete the memory skip function from the memory channel.
 - "SKIP" disappears.

■ Scan resume condition

USING SET MODE

The resume condition can be selected as a pause or timer scan. The resume condition is not only used for scan but also for priority watch.

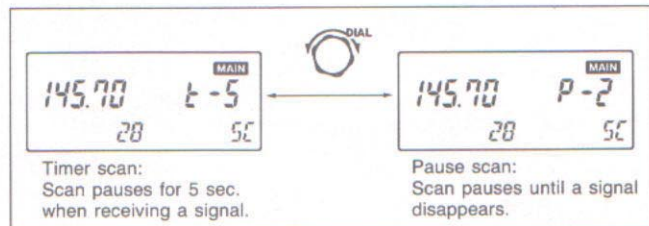

- 1) Enter SET mode:
 - Push [V MAIN] or [U MAIN] to select the desired band.
 - Push [① V/M] to select VFO mode. ("M" disappears.)
 - While pushing [F], push [⑧ SET] to enter SET mode.
- 2) Select the scan resume display:
 - Push [Δ/SCAN] or [▽/SCAN] several times until "SC" appears as shown above.
- 3) Rotate the main dial to select "timer scan" or "pause scan."
- 4) Push [⊗ CLR] to exit SET mode.

■ Priority watch types

• Memory channel watch

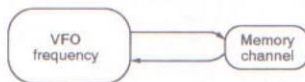

While operating in a VFO frequency, priority watch checks the selected memory channel every 5 sec.

- When the selected memory channel is masked (hidden), the watch does not start.

• Memory scan watch

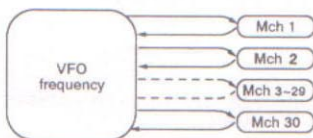

While using a VFO frequency, priority watch checks each memory channel in sequence.

- The memory skip scan can be used for shorter scanning intervals. See p. 31 for memory skip scan details.

• Call channel watch



While using a VFO frequency, priority watch checks the call channel every 5 sec.

■ Priority watch operation

- 1) Set the squelch to the threshold point.
 - When the squelch is tight, priority watch might not stop on a weak signal.
- 2) Push [V MAIN] or [U MAIN] to select the desired band.
- 3) Set the channel to be watched:
 - For memory channel watch, push [① V/M] then select the memory channel with the main dial.
 - For call channel watch, push [④ CALL] to select the call channel.
 - For memory scan watch, push and hold [Δ/SCAN] or [▽/SCAN] in MEMORY mode to start the memory scan.
- 4) Push [⑦ PRIO] to start priority watch.
 - When receiving a signal on the watching channel, priority watch pauses for 5 sec. or until the signal disappears. See the "Scan resume condition" on p. 31 for details.
 - While the watch pauses, pushing [⑦ PRIO] will disengage the pause and resume the watch.
- 5) Push [⑦ PRIO] while the display shows the operating frequency to stop the priority watch.

12 DTMF MEMORY OPERATION

■ Programming a DTMF code

The transceiver has 4 DTMF memory channels for storage of often-used DTMF codes of up to 15 digits. Only the VHF band can be used for programming.

- 1) Push [V MAIN] to select the VHF band.
- 2) While pushing [F], push [DTMF/DTMF M] to enter DTMF MEMORY mode.
- 3) Rotate the main dial to select the desired DTMF memory channel.
- 4) While pushing [F], push [8] SET to set the transceiver in the DTMF programming condition.
 - Previously programmed digits are erased.
- 5) Push the appropriate digit keys to input the DTMF code.
 - When entering a wrong digit, push [DTMF] and start again from step 4.

- 6) Push [DTMF] to store the input digits.
 - When 15 digits have been input in step 5, it is not necessary to push [DTMF].
- 7) Push [*] CLR to exit DTMF MEMORY mode.

■ Transmitting a DTMF code

The programmed DTMF code can be transmitted on either the VHF or UHF band.

- 1) Select the desired DTMF memory channel:
 - While pushing [F], push [DTMF] to enter DTMF MEMORY mode.
 - Rotate the main dial to select the desired DTMF memory channel.
 - Push [*] CLR to exit DTMF MEMORY mode.
- 2) While holding [PTT], push [DTMF] to transmit a DTMF code.
 - Pushing [DTMF] without [PTT] emits the DTMF code of the selected DTMF memory channel from the speaker.

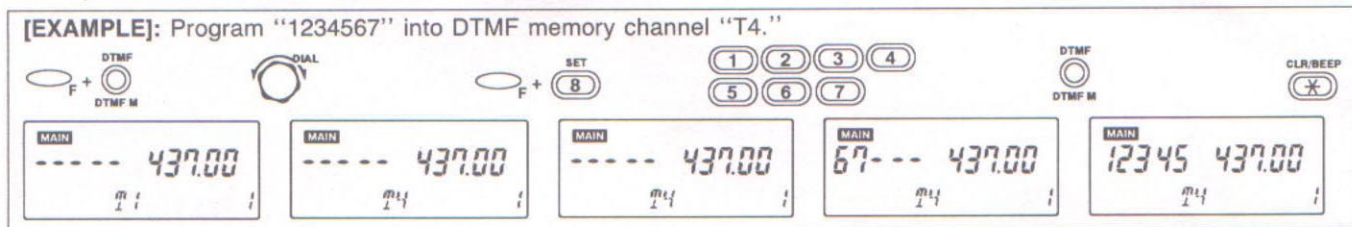

■ Beep tone

The transceiver emits a beep tone each time a switch is pushed. For silent operation, the beep tone can be turned OFF.

OPERATION

While pushing [F], push [⊛]BEEP to turn OFF and ON the beep.

NOTE

Even if the beep is OFF, the transceiver emits a beep tone for the pager function and an optional* pocket beep function.

*Built-in to the U.S.A. version.

■ Display lighting

The display lighting has a 5 sec. timer for night operation. If you need continuous lighting, follow this procedure:

OPERATION

To activate lighting for 5 sec.:

Push [③] LIGHT

To activate continuous lighting :



- While pushing [F], push [③] LIGHT].
- Push [③] LIGHT to turn the lighting OFF.

The continuous lighting remains activated even if the power is turned OFF and ON again.

■ Power saver

USING SET MODE

The power saver function reduces the current drain to conserve battery power during the standby condition. The duty cycle of the power saver can be selected and can be turned ON or OFF to suit your operating style.

			
Standby Circuit off	125 msec. 500 msec.	125 msec. 2 sec.	Power saver is turned OFF.

- 1) Enter SET mode:
 - Push [V MAIN] or [U MAIN] to select the desired band.
 - Push [①] V/M to select VFO mode. ("M" disappears).
 - While pushing [F], push [⑧] SET to enter SET mode.
- 2) Push [Δ/SCAN] or [▽/SCAN] several times to select the duty cycle setting display as shown above.
- 3) Rotate the tuning control to select the desired duty cycle or to turn the function OFF.
- 4) Push [⊛] CLR to exit SET mode.

14 CLOCK AND TIMER OPERATION

■ Auto-off function

The transceiver automatically turns OFF after a selected period in which no switch is pushed or no signal is received.

• Selecting auto-off periods

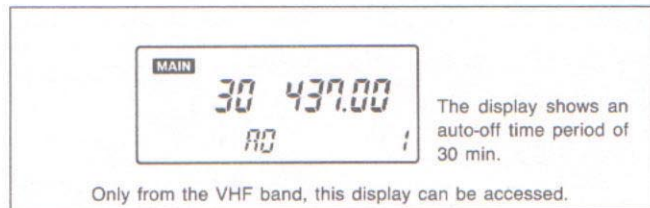

- 1) Select the auto-off display:
 - While pushing [F], push [CLOCK/AO]. Continue holding [F] until step 2 is completed.
- 2) Select the auto-off time:
 - While holding [F], rotate the main dial.
 - 60 min., 30 min. and OFF can be selected.
 - Release [F].

• Operation notes

1. The selected time is retained even after the transceiver is turned OFF by the auto-off function.
2. To cancel the function, select "OFF" in step 2 above.

■ Clock mode

The transceiver is equipped with a clock for operating the power-on and power-off timers.

When only the VHF band is selected as the main band, clock and timer settings are available. Both the VHF and UHF bands have a clock display.

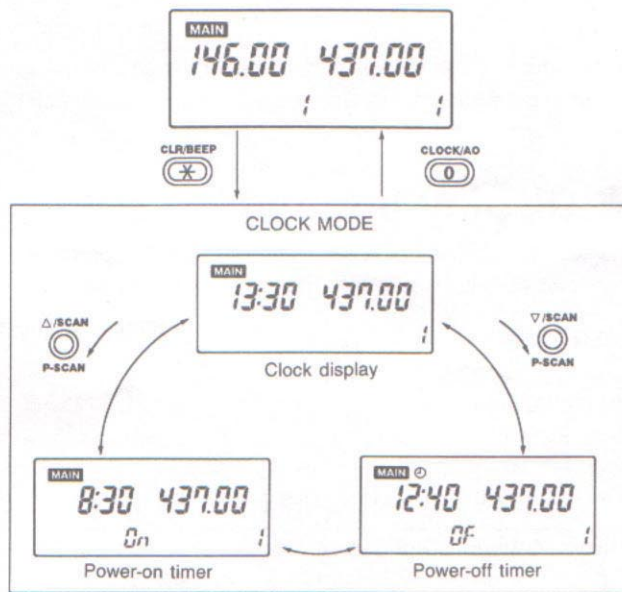

■ Clock operation

• Setting time

Only the VHF band can be used for clock setting.

1) Enter CLOCK mode:

- Push [V MAIN] to select the VHF band.
- Push [CLOCK] to access CLOCK mode.

2) Set the time:

- While pushing [F], push [SET] to set the transceiver in the time setting condition.
- Rotate the main dial to set the hour.
- Push [Δ/SCAN] or [▽/SCAN], then rotate the main dial to set the minute.
- When a wrong time is set, push [CLR] and begin this procedure again.
- Push [ENT] to enter the time.

3) Exit CLOCK mode:

- Push [CLR].

• Clock indication

1. To display the clock, push [CLOCK].
 - On both the VHF and UHF band displays, the clock can be indicated.
2. To make the clock disappear, push [CLR].
3. Receiving are possible even when the clock display is indicated.

TIME ERROR: ± 1 min./week

NOTE: CPU resetting clears the clock time. Set the time again, if desired.

[EXAMPLE]: Set the time for 13:45.

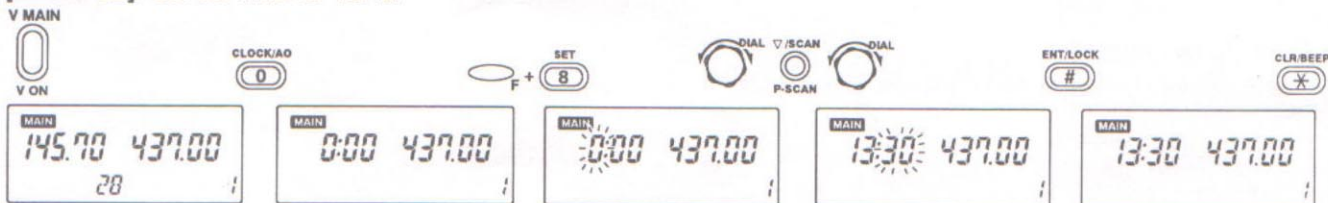

14 CLOCK AND TIMER OPERATION

■ Power-on timer

The transceiver has a power-on timer to fit your schedule and conserve battery power.

• Setting power-on time

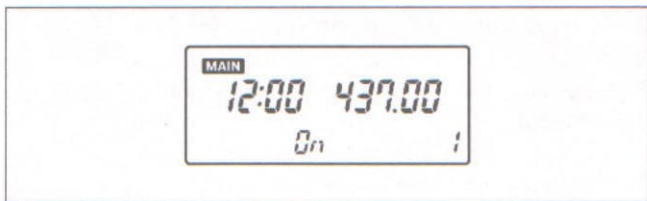

- 1) Enter CLOCK mode:
 - Push [V MAIN] to select the VHF band.
 - Push [CLOCK] to access CLOCK mode.
- 2) Select the power-on display:
 - Push [Δ/SCAN] to select the display as shown above.
- 3) Recall the previously set time:
 - While pushing [F], push [MASK].
- 4) Set the power-on time:
 - While pushing [F], push [SET] to set the transceiver in the time-setting condition.
 - Rotate the main dial to set the hour.
 - Push [Δ/SCAN] or [▽/SCAN], then rotate the main dial to set the minute.
 - Push [ENT] to enter the time.

- 5) Exit CLOCK mode:
 - Push [CLR].

• Power-on timer operation

1. The power-on timer will turn power ON at the set time after power is OFF.
 - 5 beeps sound when the preset time arrives.
2. The preset time will be masked when the transceiver is turned ON by the power-on timer.
 - The programmed time is retained even after power is turned ON by the [POWER] switch.
3. To deactivate the timer function, set the power-on time to be masked. Repeat steps 1 ~ 3 in "Setting power-on time" to select the masked display.

[EXAMPLE]: Set the power-off time for 12:40.

V MAIN



V ON

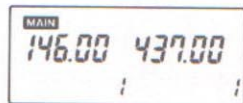

CLOCK/AO

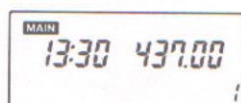

Δ/SCAN



P-SCAN

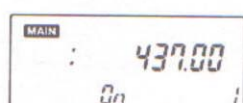

SKIP/MASK

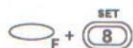
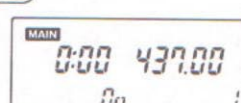
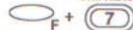

SET

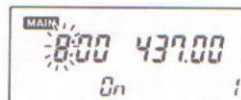
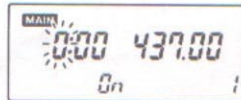

▽/SCAN



P-SCAN

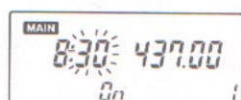

ENT/LOCK

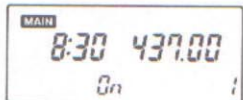

CLR/BEEP

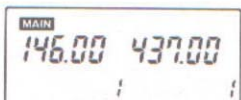

POWER



When the set time of 8:30 arrives.

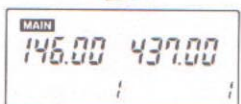

Turn power OFF.

■ Power-off timer

The transceiver has a power-off timer separate from the auto-off function to turn power OFF at the preset time.

• Setting power-off time

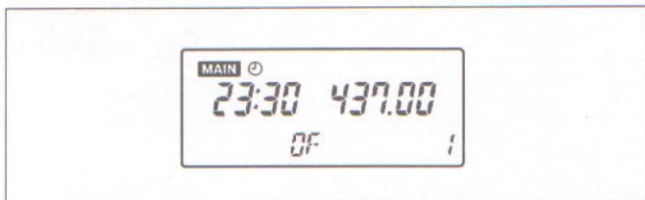

- 1) Enter CLOCK mode:
 - Push [V MAIN] to select the VHF band.
 - Push [C] CLOCK] to access CLOCK mode.
- 2) Select the power-off display:
 - Push [▽/SCAN] to select the display as shown above.
- 3) Recall the previously set time:
 - While pushing [F], push [7] MASK].
- 4) Set the power-off time:
 - While pushing [F], push [8] SET] to set the transceiver in the time-setting condition.
 - Rotate the main dial to set the hour.
 - Push [△/SCAN] or [▽/SCAN], then rotate the main dial to set the minute.
 - Push [ENT] to enter the time.

- 5) Exit CLOCK mode:
 - Push [CLR].

• Power-off timer operation

1. "C" appears on the display when the power-off timer is activated.
2. The power-off timer will turn power OFF at the set time.
 - 5 beeps sound when the preset time arrives.
3. The preset time will be masked when the transceiver is turned OFF by the power-off timer.
 - The programmed time is retained even after the transceiver is turned OFF by the [POWER] switch at the preset time.
4. To deactivate the timer function, set the power-off time to be masked. Repeat steps 1 ~ 3 in "Setting power-off time" to select the masked display.

[EXAMPLE]: Set the power-on timer for 8:30.

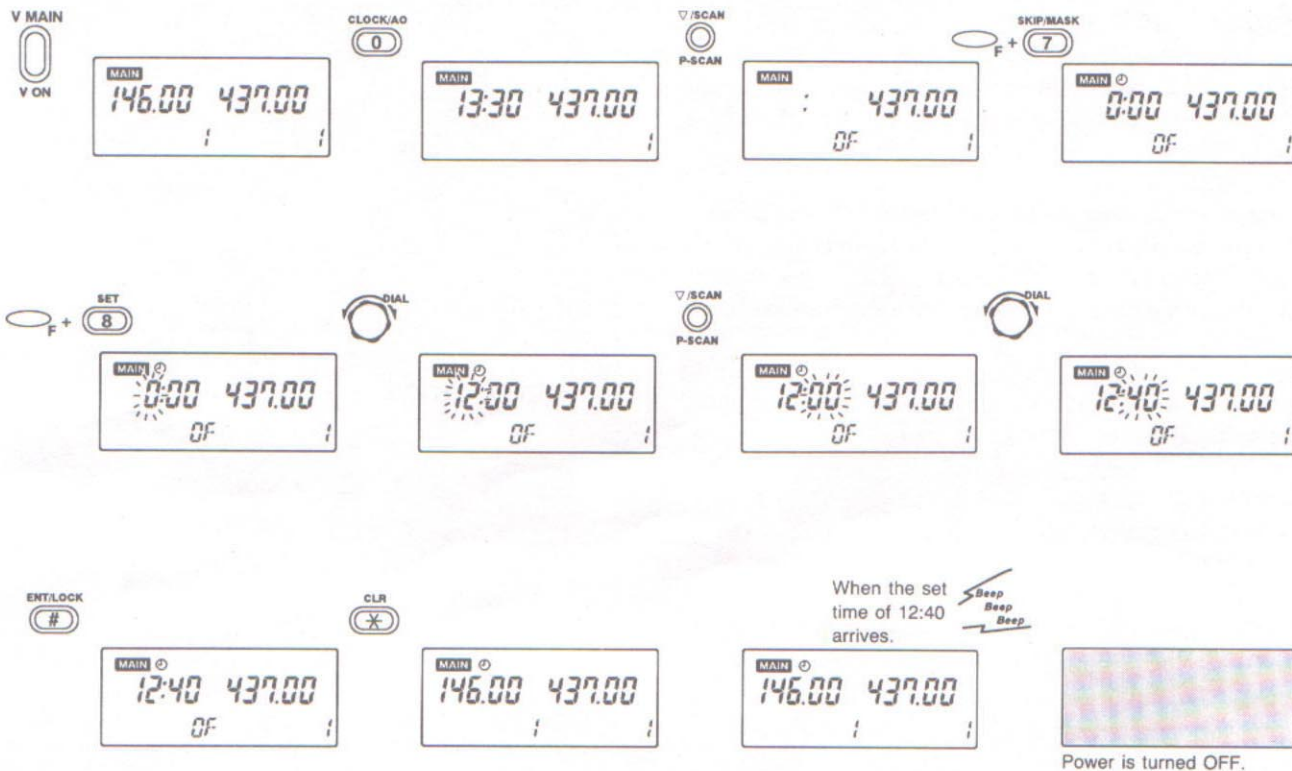

15 PAGER AND CODE SQUELCH

■ General description

• Pager function

The pager function is a selective calling system that allows you to contact a specified station or all stations in your group. To use the pager function in your group, all stations need the pager function.

The pager function informs another station with your ID code which is determined in your group. The ID code appears on the other station's display and is stored there for easy answer-back. Beeps will be emitted to indicate transmission of your ID code.

The pager function transmits a code with 7 DTMF digits: Transmit code + "*" + Your ID code.

• Code squelch

The code squelch allows you silent standby since you will only receive calls from stations which know your ID code.

The code squelch transmits a 3-digit code prior to voice transmission.

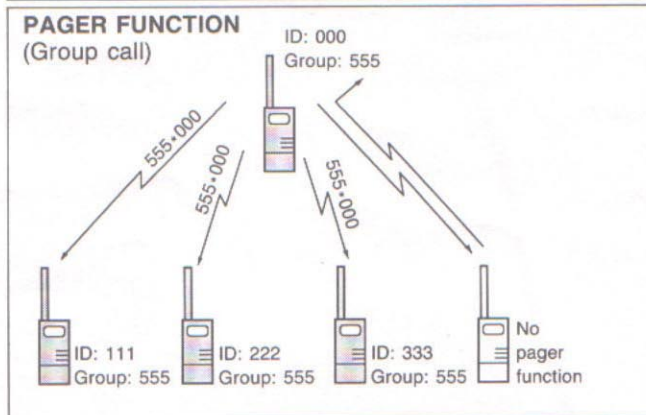
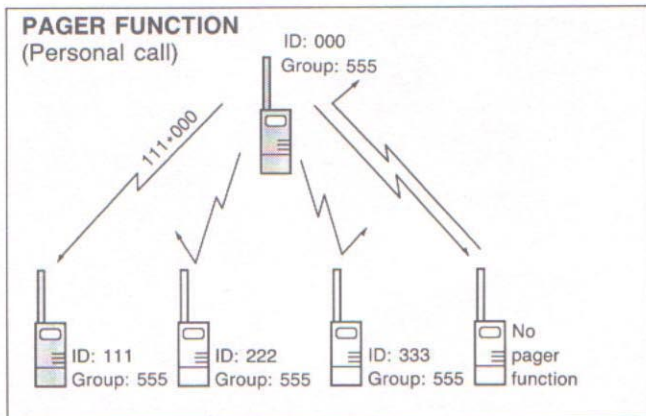

■ Code programming

• Before programming

Before operating the pager function, the following are necessary for determining your group.

- ID code of each transceiver and the group code in your group.
- Specification of "with code squelch" or "without code squelch" for communication after contact.

• Channel assignment

ID or group code	Code memory channel	"Receive accept" or "Receive inhibit"
Your ID code	C0	"Receive accept" only
Other station's ID codes	C1 ~ C5	"Receive inhibit" should be programmed in each channel.
Group code	One of C1 ~ C5	"Receive accept" must be programmed.
Memory space*	CP	"Receive inhibit" only

* Channel CP automatically memorizes an ID code when receiving a pager call. The contents in channel CP cannot be changed manually.

RECEIVE INHIBIT

To receive the signal only you need, transmit code should be inhibit the reception, since the other station's ID codes are programmed in transmit codes.

• Programming

- 1) Push [V MAIN] or [U MAIN] to select the desired band to be programmed.
 - VHF and UHF bands have separate code memory channels.
- 2) While pushing [F], push [© CODE] to select the code memory setting display.
- 3) Rotate the main dial to select the desired code memory channel.
- 4) Push numeral keys to enter the desired digit codes.
- 5) Push [© PGR/C SQL] to set the channel for "receive inhibit" ("SKIP" appears) or "receive accept" ("SKIP" does not appear).
 - See the table at left for "receive inhibit" or "receive accept" details.
- 6) Push the selected band switch, [V MAIN] or [U MAIN] to exit the setting display.

■ Pager operation

• Calling a specific station

- 1) Push [V MAIN] or [U MAIN] to select the desired band.
 - The pager function cannot be turned ON simultaneously in the VHF and UHF bands.
- 2) Push [ⓈPGR/C SQL] to turn the pager function ON.
 - "PGR" appears.
- 3) Select the desired code memory channel to be used as a transmit code:
 - While pushing [F], push [ⓈCODE].
 - Rotate the tuning control to select the channel.
 - Push the selected band switch, [V MAIN] or [U MAIN], to exit the setting display.
- 4) Push [PTT] to transmit the digit code.
- 5) Wait for an answer back.
 - When the transceiver receives an answer back code, the function display shows the other station's ID or group code.
- 6) After confirming a connection, push the selected band switch, [V MAIN] or [U MAIN], to display the operating frequencies.
- 7) Push [ⓈPGR/C SQL] once to select the code squelch or twice to select the non-selective calling system.

• Waiting for a call from a specified station

- 1) Push [V MAIN] or [U MAIN] to select the desired band.
 - The pager function cannot be turned ON simultaneously in the VHF and UHF bands.
- 2) Push [ⓈPGR/C SQL] to turn the pager function ON.
 - "PGR" appears.
- 3) When receiving a call with a correct code, the transceiver emits a beep and the function display shows the code as shown on the page at right.
- 4) Push [PTT] to send an answer back call.
 - The display shows the operating frequency.
- 5) Push [ⓈPGR/C SQL] once to select the code squelch or twice to select the non-selective calling system.

PERSONAL CALL

When you receive a call with your ID code and received ID code is "111," the display at right appears.

**GROUP CALL**

When you receive a call with the group code of "555" and you have programmed "555" into code channel C5, the display at right appears.

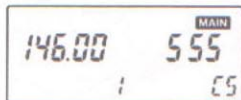
**ERROR INFORMATION**

When the transceiver receives an incomplete signal, "E" appears.

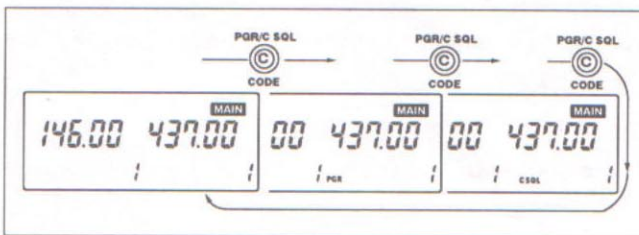
**Code squelch operation**

- 1) Push [V MAIN] or [U MAIN] to select the desired band.
 - Code squelch cannot be turned ON simultaneously in the VHF and UHF bands.
- 2) Push [C PGR/C SQL] twice to turn the code squelch ON.
 - "C SQL" appears.
- 3) Select the code memory channel which contains the transmit code or group code:
 - While holding [F], push [C CODE].
 - Rotate the main dial to select the channel.
 - Push the selected band switch, [V MAIN] or [U MAIN], to exit the setting display.
- 4) Operate the transceiver in the normal way (push [PTT] to transmit; release [PTT] to receive).
 - 3-digit code is transmitted when pushing [PTT].
- 5) To cancel the code squelch, push [C PGR/C SQL]

16 POCKET BEEP AND TONE SQUELCH

■ UT-63 installation

The UT-63 is already installed in the IC-W2A U.S.A version. For other versions, an optional UT-63 must be purchased separately.

- 1) Turn power OFF, then remove the battery pack from the transceiver.
- 2) Unscrew 5 screws from the rear of the transceiver.
- 3) Unscrew 2 screws from the side of the transceiver.
- 4) Remove the rear panel.
- 5) Pull out the terminal board.
- 6) Install and plug the UT-63 as shown in the diagram at right.
- 7) Replace the terminal board and rear panel.
- 8) Tighten the 7 screws.

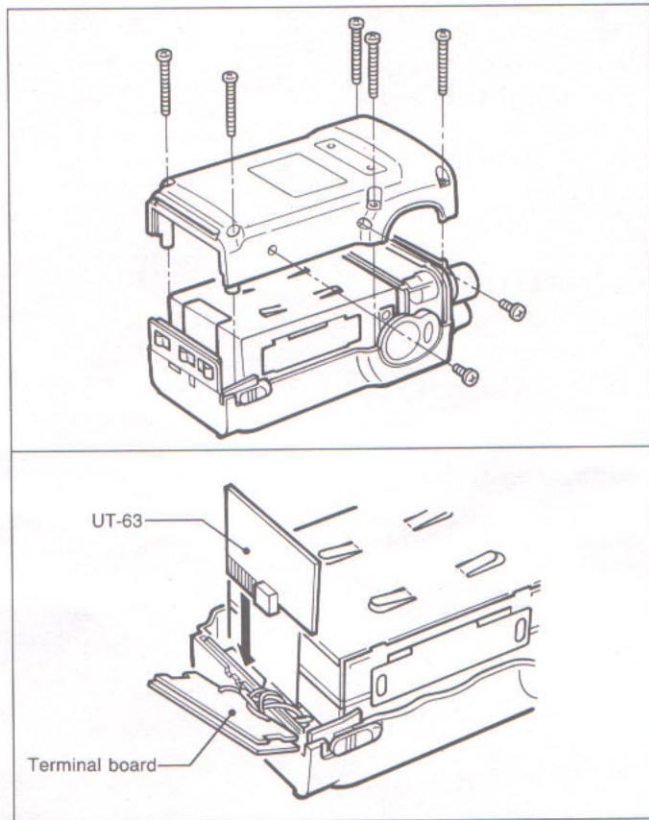

■ Pocket beep

The pocket beep function alerts you for approx. 30 sec. with beep tones and a flashing “(••)” on the display when you receive a call including the same subaudible tone as that pre-programmed.

The pocket beep cannot be used in combination with the pager or code squelch.

- 1) Program the subaudible tone frequency in SET mode.
 - See p. 20 for programming details.
- 2) Push [ⓑ T/P.B/T SQL] several times until “(••)” appears on the function display.
- 3) When a signal including the correct tone is received, the transceiver emits beep tones for 30 sec. and flashes “(••).”
- 4) Push [PTT] or the selected band switch [V MAIN] or [U MAIN] to stop the beeps and flashing.
 - Tone squelch is automatically selected.

■ Tone squelch

The tone squelch opens only when receiving a signal with the same subaudible tone as that pre-programmed. You can silently wait for a call from group members using the same tone.

- 1) Program the subaudible tone frequency in SET mode.
 - See p. 20 for programming details.
- 2) Push [ⓑ T/P.B/T SQL] several times until “T SQL” appears on the function display.
- 3) When the received signal includes the correct tone, the squelch opens and the signal can be heard.
 - When the received signal includes an incorrect tone, the squelch does not open. Only the green indicator lights up.
 - To open the squelch manually, push and hold [MONI].
- 4) Operate the transceiver in the normal way (push [PTT] to transmit; release [PTT] to receive).
- 5) To cancel the tone squelch, push [ⓑ T/P.B/T SQL] several times until “T” or “T SQL” disappears from the function display.

17 TROUBLESHOOTING GUIDE

PROBLEM	POSSIBLE CASE	SOLUTION	REF.
<ul style="list-style-type: none"> No power comes on. 	<ul style="list-style-type: none"> The battery pack is empty. Poor plug connection of the external DC power cable. 	<ul style="list-style-type: none"> Charge the battery pack or place new dry cell batteries in the battery case. Check the connector or remove the cable. 	p. 11
<ul style="list-style-type: none"> Beeps sound and the power cannot be turned OFF. 	<ul style="list-style-type: none"> The battery pack is empty. 	<ul style="list-style-type: none"> Detach the battery pack and charge the battery pack or place new dry cell batteries in the battery case. 	p. 11
<ul style="list-style-type: none"> No sound comes from the speaker. 	<ul style="list-style-type: none"> A [SQL] control is turned too far clockwise. The battery pack is empty. Pager or code squelch is activated. 	<ul style="list-style-type: none"> Rotate the [SQL] control counterclockwise. Charge the battery pack or place a new dry cell batteries in the battery case. Push [C] PGR/C SQL several times to turn OFF the function. 	<p>p. 3</p> <p>p. 11</p> <p>p. 43</p>
<ul style="list-style-type: none"> No transmitting is possible or only low power can be used. 	<ul style="list-style-type: none"> The battery is empty. The PTT lock function is activated. Low power is selected on the selected band. 	<ul style="list-style-type: none"> Charge the battery pack or place new dry cell batteries in the battery case. While pushing [F], push [6] P.L. to cancel the function. Push [9] HI/LOW to select high output power. 	<p>p. 11</p> <p>p. 18</p> <p>p. 18</p>
<ul style="list-style-type: none"> Frequency cannot be set. 	<ul style="list-style-type: none"> The lock function is activated. The call channel is selected. 	<ul style="list-style-type: none"> While pushing [F], push [7] LOCK to turn OFF the lock function. Push [4] CALL to exit call channel mode. 	<p>p. 15</p> <p>p. 23</p>
<ul style="list-style-type: none"> Scan cannot be activated. 	<ul style="list-style-type: none"> The call channel is selected. Priority watch is activated. The squelch of the selected band is open. 	<ul style="list-style-type: none"> Push [4] CALL to exit call channel mode. Push [C] PRIO. to deactivate the priority watch. Rotate the [SQL] control clockwise. 	<p>p. 23</p> <p>p. 32</p> <p>p. 28</p>

GENERAL

- Frequency coverage:

VERSION	Tx/Rx	FREQUENCY COVERAGE	
		VHF	UHF
IC-W2A (U.S.A)	Transmit	140 ~ 150*	440 ~ 450
	Receive	136 ~ 174*	440 ~ 450
IC-W2A (Australia)	Both Tx and Rx	144 ~ 148	430 ~ 440
IC-W2A (Asia)	Transmit	140 ~ 150*	430 ~ 440
	Receive	138 ~ 174*	430 ~ 440
IC-W2E (Europe)	Both Tx and Rx	144 ~ 146	430 ~ 440
IC-W2E (Italy)	Transmit	140 ~ 150*	430 ~ 440
	Receive	138 ~ 174*	430 ~ 440

*Guaranteed frequency coverage is 144 ~ 148 MHz

- Mode : FM (F3)
- Tuning steps : 5, 10, 12.5, 15, 20, 25, 30 and 50 kHz; and 100 kHz, 1 MHz for dial select steps.
- Antenna impedance : 50 Ω (nominal)
- Usable battery pack : BP-81 ~ BP-85 or BP-90
- External DC power supply : 6 ~ 16 V DC (negative ground)
- Current drain (typical):

CONDITION		VHF	UHF
Transmit (13.5 V)	High	1.3 A	1.8 A
	Low 1	500 mA	700 mA
Receive (12.5 V)	Mono band	Power saved	20 mA*
		Rated audio output	150 mA
	Dual band	Power saved	40 mA*
		Rated audio output	200 mA

*Average value

- Usable temperature range : -10°C ~ +60°C; +14°F ~ +140°F

- Dimensions and weight (Projections not included)

VERSION	DIMENSIONS	WEIGHT	BATTERY PACK
IC-W2A (U.S.A)	54(W) × 170(H) × 36(D) mm 2.1(W) × 6.7(H) × 1.4(D) in	530 g 1.2 lb	BP-84
IC-W2A (Australia)	54(W) × 135(H) × 36(D) mm 2.1(W) × 5.3(H) × 1.4(D) in	400 g 14.1 oz	BP-82
IC-W2A (Asia)	54(W) × 154(H) × 36(D) mm 2.1(W) × 6.1(H) × 1.4(D) in	450 g* 15.9 oz*	BP-90
IC-W2E (Europe, Italy)	54(W) × 154(H) × 36(D) mm 2.1(W) × 6.1(H) × 1.4(D) in	450 g 15.9 oz	BP-83

*Weight includes 6 dry cell batteries.

TRANSMITTER

- Output power (13.5 V) : High More than 5.0 W
Low 3 Approx. 3.5 W
Low 2 Approx. 1.5 W
Low 1 Approx. 500 mW
- Modulation system : Variable reactance frequency modulation
- Maximum frequency deviation : ± 5 kHz
- Spurious emissions : Less than -60 dB

RECEIVER

- Sensitivity : Less than 0.16 μ V for 12 dB SINAD
- Squelch sensitivity : Less than 0.13 μ V
- Intermediate frequencies : VHF 1st 30.85 MHz 2nd 455 kHz
UHF 1st 35.80 MHz 2nd 455 kHz
- Receive system : Double-conversion superheterodyne
- Audio output power : 180 mW at 10% distortion with an 8 Ω load

All stated specifications are subject to change without notice or obligation.

Count on us!

A-5143S-1EX-①
Printed in Japan
Copyright © 1991 by Icom Inc.

Icom Inc.
6-9-16, Kamihigashi, Hirano-ku, Osaka 547, Japan